

ERL requirements

BLM designs

- Ionization chambers
- Long ionization chambers
- Secondary emission monitors
- PIN diodes
- Photomultiplier with bulk scintillator
- Bare photomultiplier
- Photomultiplier with fibers

Examples

- JLAB FEL
- SNS, Oak Ridge
- FLASH, DESY

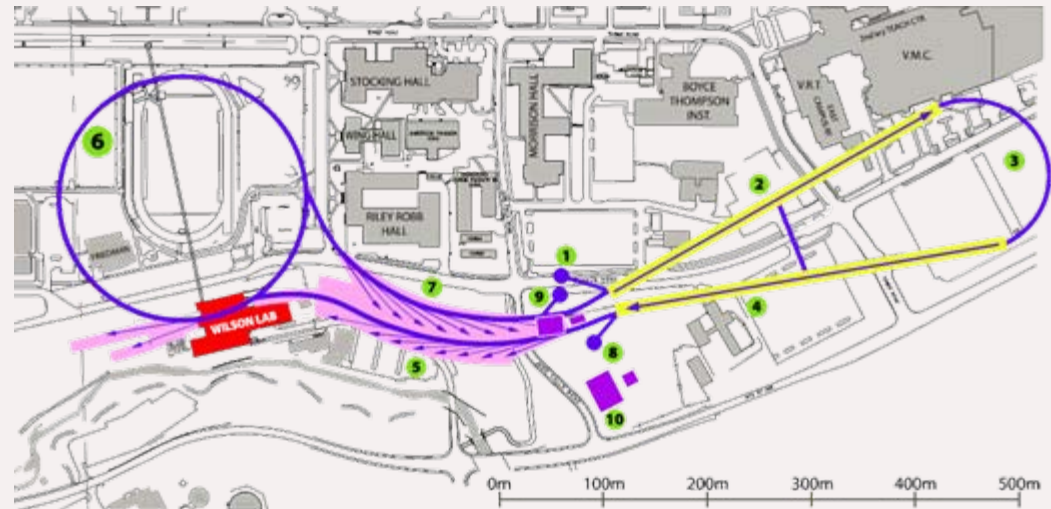



Basics



Hazards



- **Direct mechanical damage**
(heat load on vacuum chambers and components)
- **Indirect damage**
by showers/radiation field
(electronics, optical components, permanent magnets)
- **Radio-activation**
of accelerator parts
(may prevent hands-on maintenance)
- **Quenches**
of superconducting components
(magnets: damage/downtime,
cavities: fast beam losses)
- Fast machine protection system needed: response time few microseconds (cables!)
- Shielding and precise control even of low beam losses needed
- Hands-on maintenance: no more than 1 mSv/hour residual activation (30 cm from surface, after 4 h cool-down)

$$100 \text{ rem} = 1 \text{ Sv}$$

$$100 \text{ rad} = 1 \text{ Gy}$$

Electronic interactions in matter

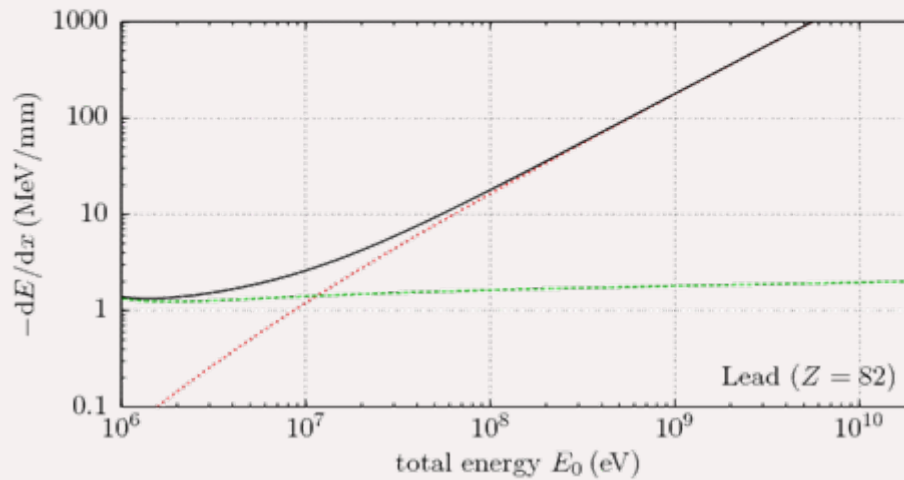
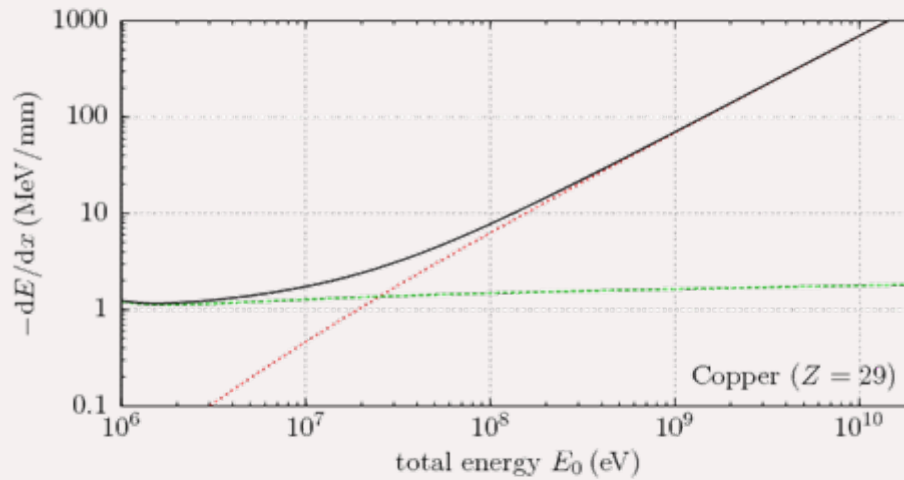
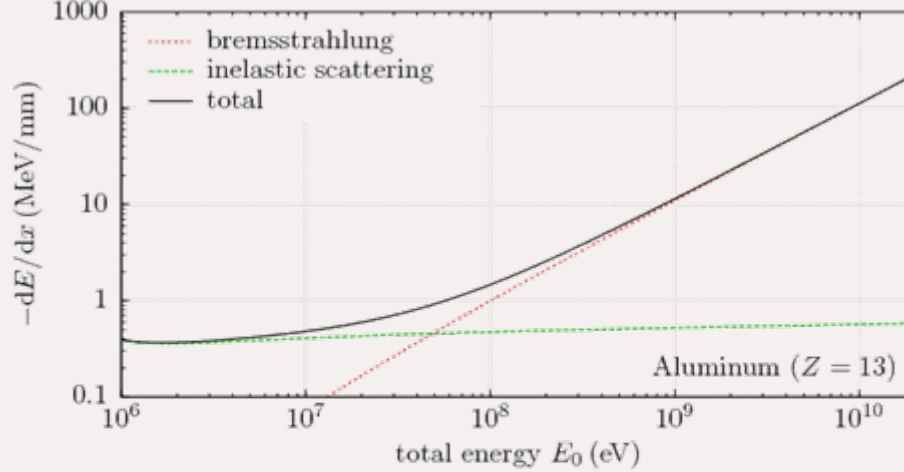

Inelastic scattering at atomic electrons:
 energy loss $\sim 2 \text{ MeV}\cdot\text{cm}^2/\text{g}$
 $\sim 2 \text{ MeV}/\text{cm}$ for $\rho=1 \text{ g}/\text{cm}^3$

Photonic interactions in matter

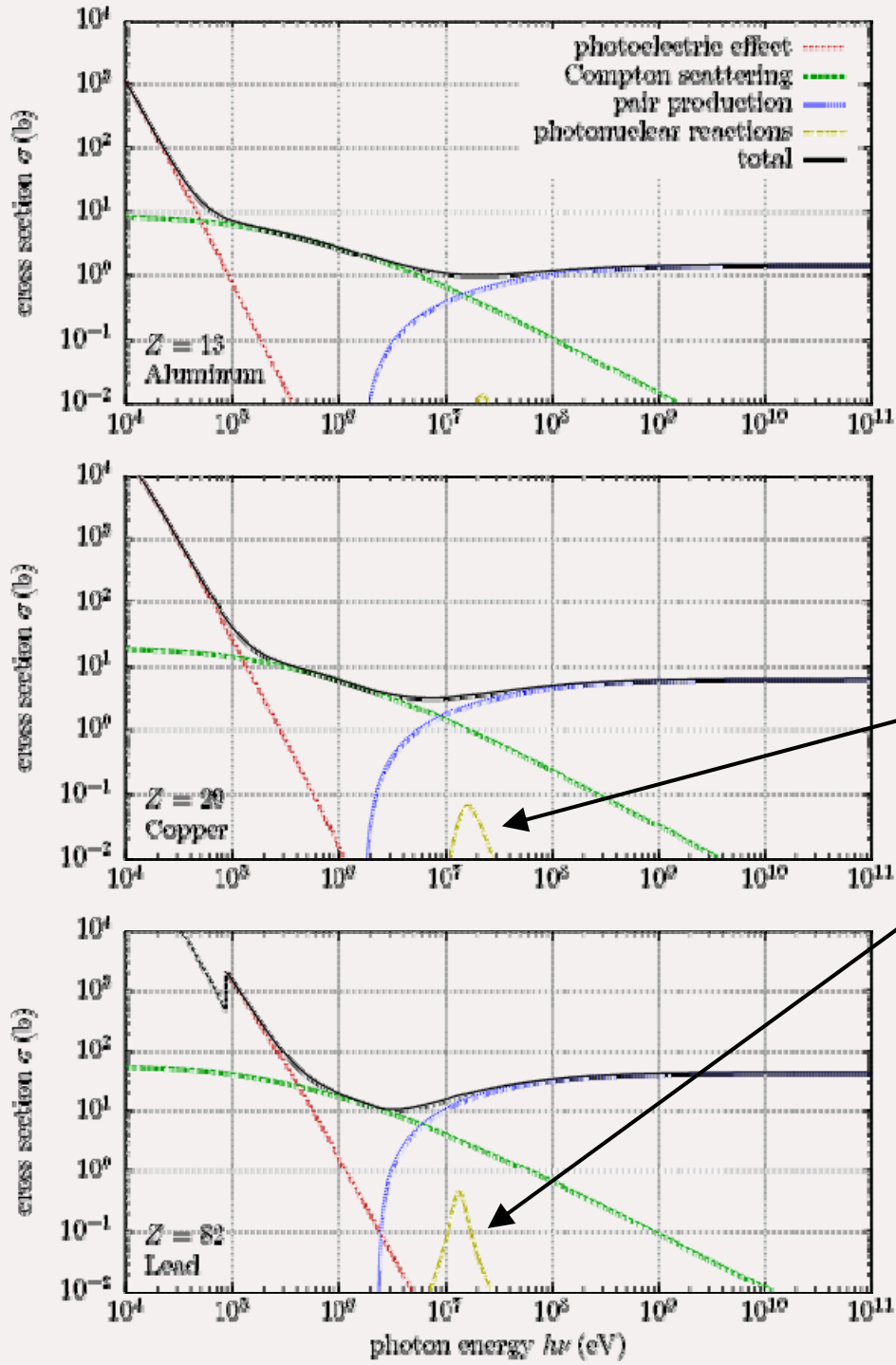

Photoneutrons are a problem at electron machines!



ERL requirements



Cornell ERL Parameters



Hi-flux mode

$$E_{\text{beam}} = 5 \text{ GeV}$$

$$I_{\text{beam}} = 100 \text{ mA}$$

$$P_{\text{beam}} = 500 \text{ MW}$$

$$Q_{\text{bunch}} = 77 \text{ pC}$$

$$f_{\text{bunch}} = 1.3 \text{ GHz}$$

$$\varepsilon_{\text{norm}} = 0.3 \text{ mm}\cdot\text{mrad}$$

$$\delta_{\text{rms}} = 0.2 \cdot 10^{-3}$$

Beam loss goals

15 nA (relative: $1.5 \cdot 10^{-7}$)

5 W

Behind collimators:

$\sim 1 \text{ pA/m}$

$\sim 5 \text{ mW/m}$



$6 \cdot 10^6 \text{ electrons / (s} \cdot \text{m)}$
 $5 \cdot 10^{-3} \text{ electrons / (bunch} \cdot \text{m)}$
**may lose an electron from a
bunch each 200 m**

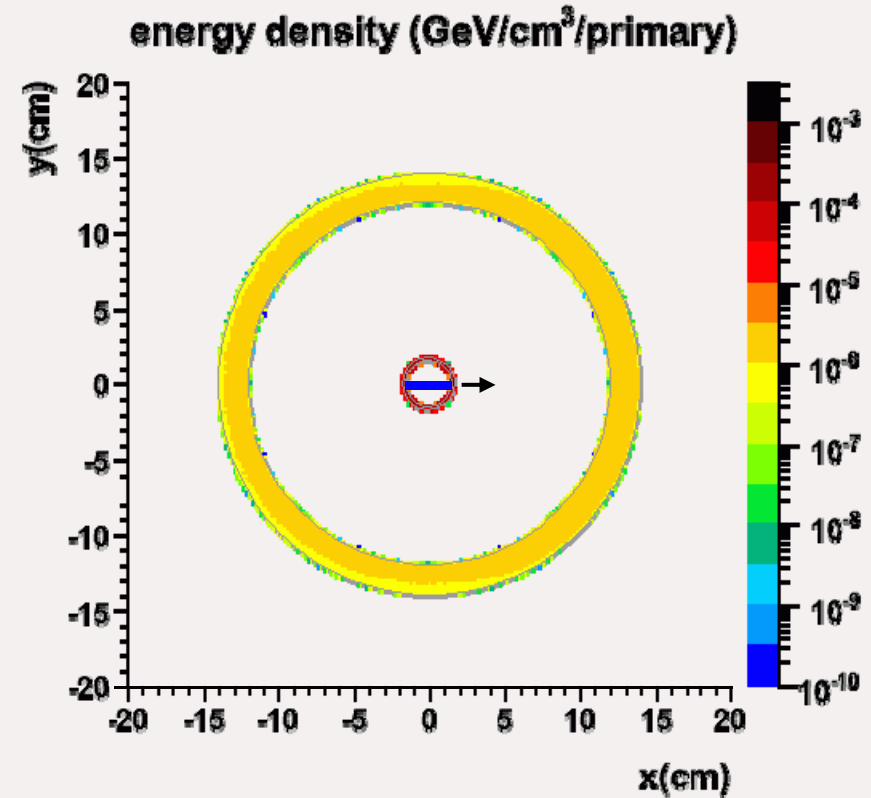
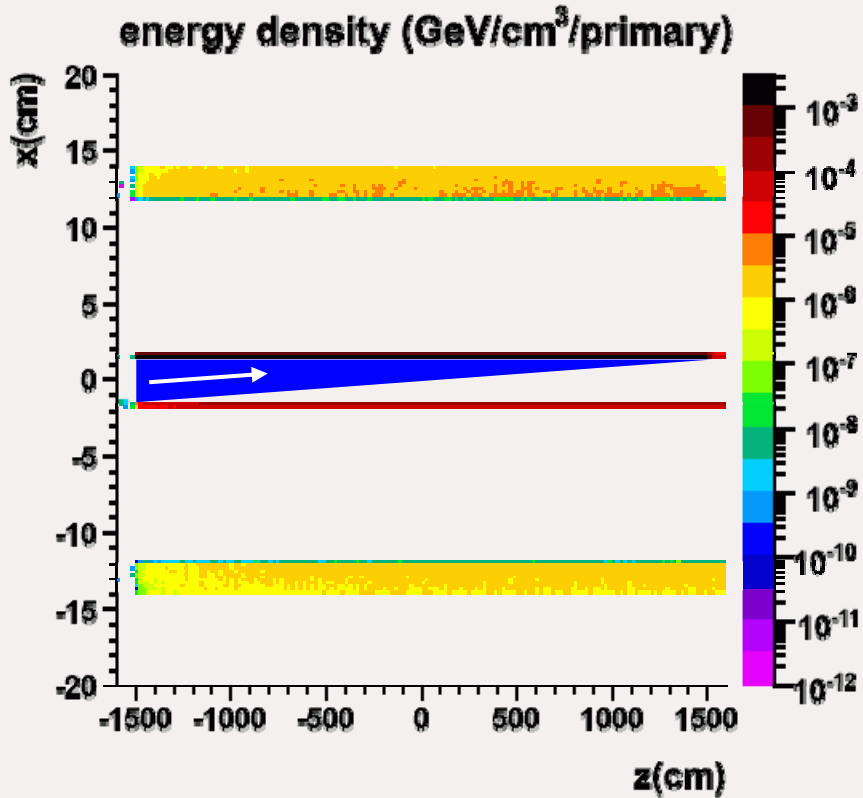

- Assume an average loss of 1 W/m (200 pA/m at 5 GeV)
- Fluka simulation \rightarrow dose rate at BLM:
63 Gy/h = 550 kGy/a (if machine is running 24/7)
- aim at **few 100 kGy/a**



More Rough Estimates



Insertion device radiation dose

- similar Fluka simulation for the dose deposited in undulator magnets
- goal: no more than 10 Gy/d to avoid loss of magnetization
- maximum average beam loss allowed: **~ 60 fA/m**

BLM sensitivity range

- Lower bound:
must detect 1% of 60 fA/m loss
→ ~ 200 μ Gy/h at BLM
→ ~ 10 μ Gy/h at BLM for unfavorable position
- Upper bound:
may saturate above 1 W/m
→ ~ 60 Gy/h at BLM
- Range: 10 μ Gy/h vs. 60 Gy/h
→ **$\sim 10^7$** (but not in one location)



Additional BLM Requirements



- **Time resolution**
must detect beam loss within $\sim 1 \mu\text{s}$
- **RAMI**
reliability, availability, maintainability, inspectability
- **Self-test**
periodic functionality / calibration check
- **Cost**
as cheap as possible



BLM designs: Ionization Chamber

- Very radiation hard (no plastics or optical components)
- Medium sensitivity
- High dynamic range (10^5 – 10^8)
- Slow ion collection (electrons collected in few μs , ions in several 10 μs up to ms)
- Calibration simple (determined by geometry, relatively independent of HV)
- No simple self-test

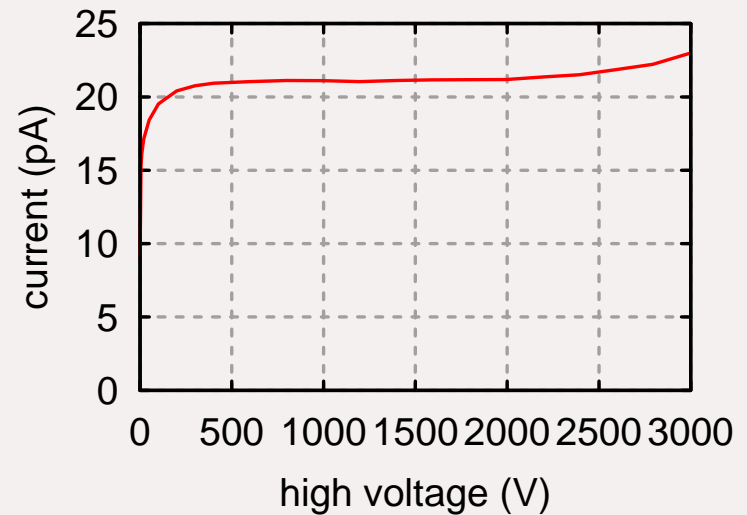
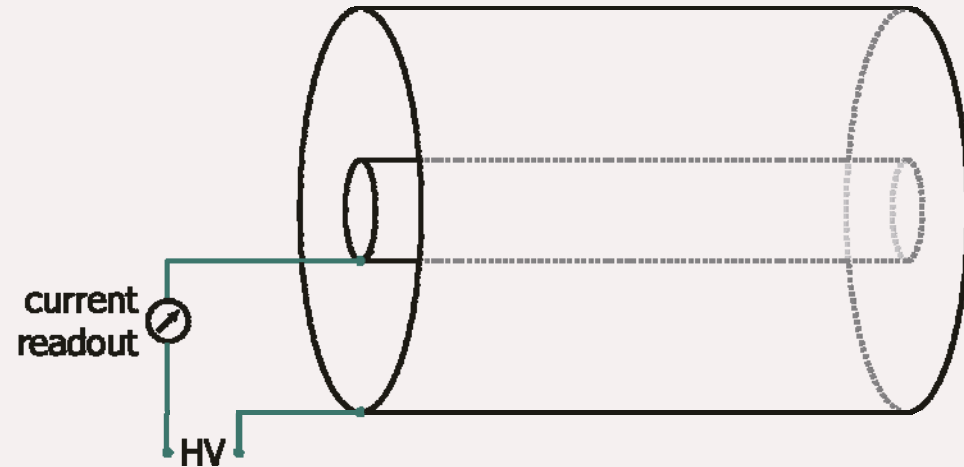

- **inner electrode**
diameter 1/4" (0.64 cm), usually +
- **outer electrode**
diameter 1.5" (3.81 cm), usually -
- **filling**
110 cm³ argon, ~1 bar
(zero electron affinity → fewer recombinations)
- **electron signal**
drift velocity at 2 kV: 5 mm/μs →
signal rise time few μs
- **ion collection**
collection time ~600 μs at 3 kV
→ early saturation at high loss rates
- **price**
~450 \$ (2002)

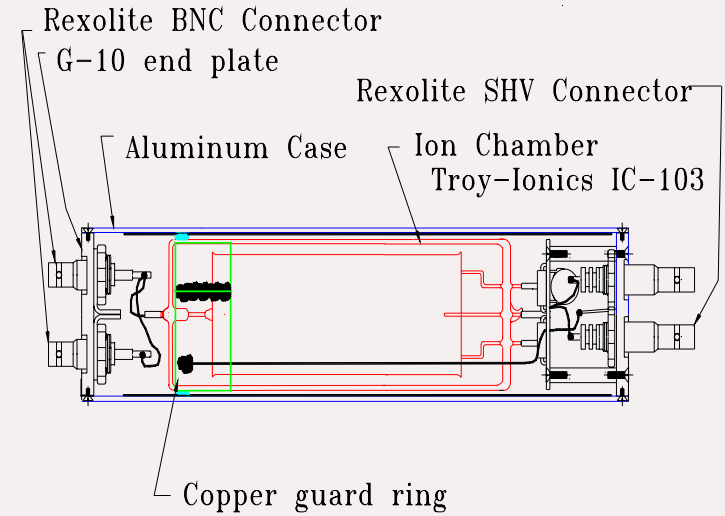

R. E. Shafer (TechSource, Inc.)
R. Witkover, D. Gassner (SNS)

- improved FNAL design
- better HV design → up to 3.7 kV
- bigger diameter of inner electrode 1" instead of 1/4", (2.54 cm instead of 0.64 cm)
- faster ion collection (1/e: 20 μs)
- better collection efficiency
- price: ~800 \$ (2002 estimate)

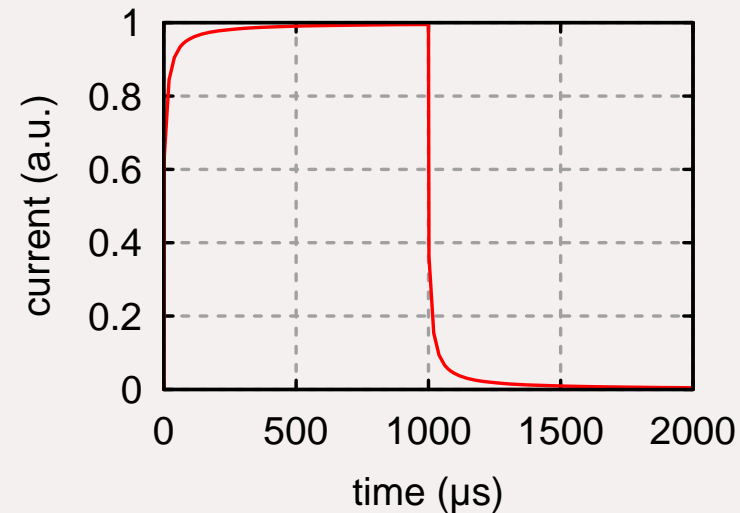
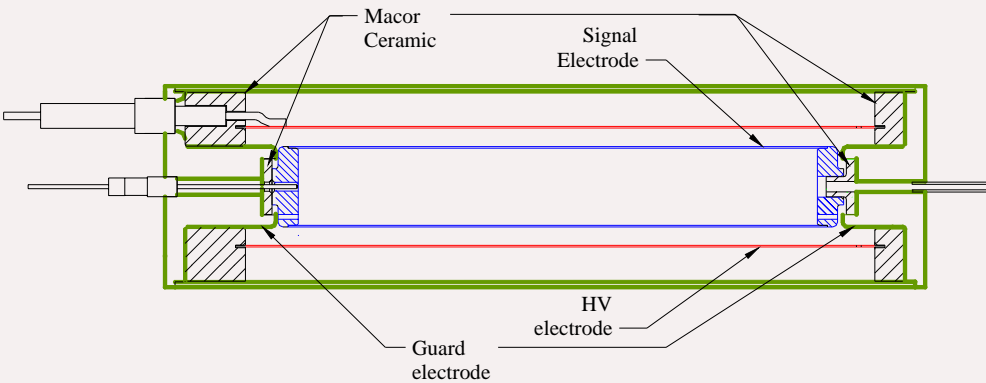
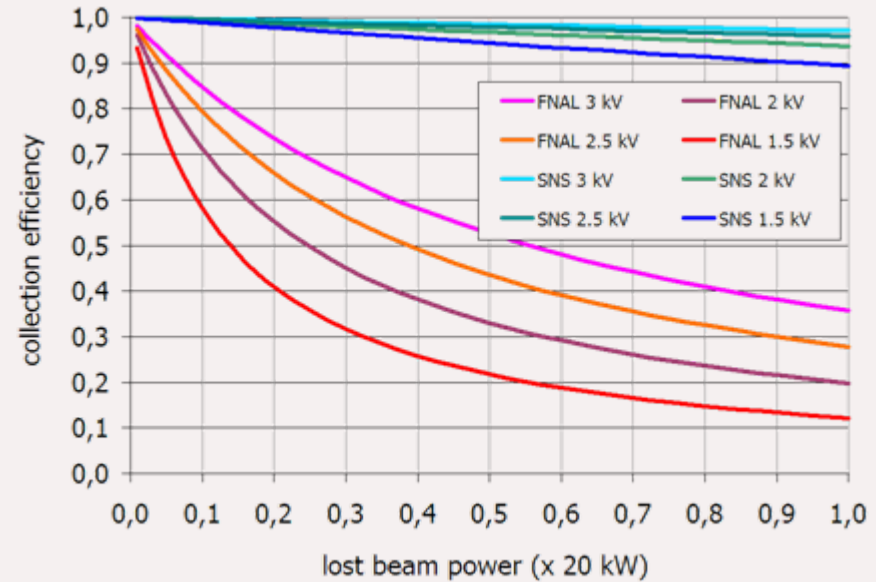

R. Witkover, D. Gassner (SNS)

- parallel aluminum electrodes, 5 mm spacing
- length: ~ 60 cm
- diameter: ~ 9 cm
- volume: 1.5 l
- filling: N_2 at 110 kPa (1.1 bar)
- high voltage: 1.5 kV
- ion collection time: 200 μs
- ~ 3600 pieces in LHC

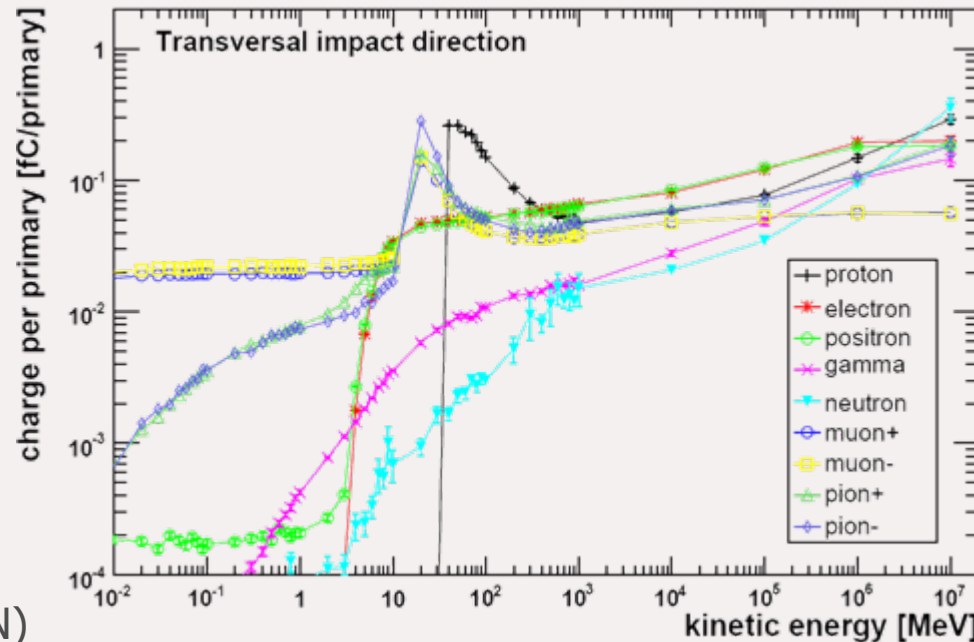
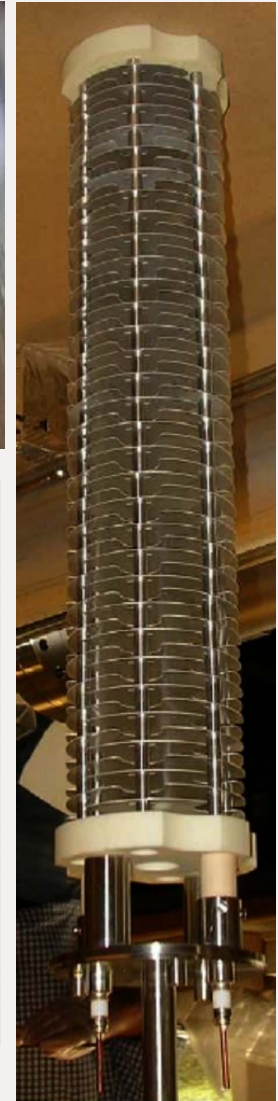

B. Dehning, M. Stockner (CERN)



BLM designs: Long Ionization Chamber

Long Ionization Chamber

- long gas-filled coax cable
- relatively low HV (typically 200 V to 500 V)
- typical length: 30–100 m (SLAC original: 3 km!)
- longitudinal loss position from signal propagation time (resolution ~ 1 m)
- fast: signal decay $< 1 \mu\text{s}$ possible
- sensitivity comparable to discrete ion chamber
- leakage currents: $< 1 \text{ pA/m}$
- radiation hard (careful with choice of insulation and spacer!)
- **cheap**

PLIC
Panofsky Long Ion Chamber

LION / LIC
Long Ion Chamber

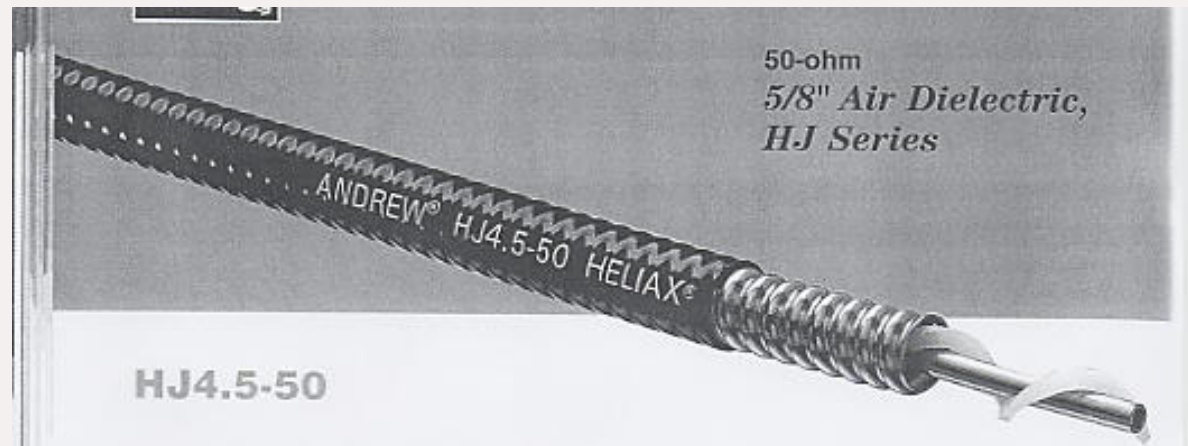

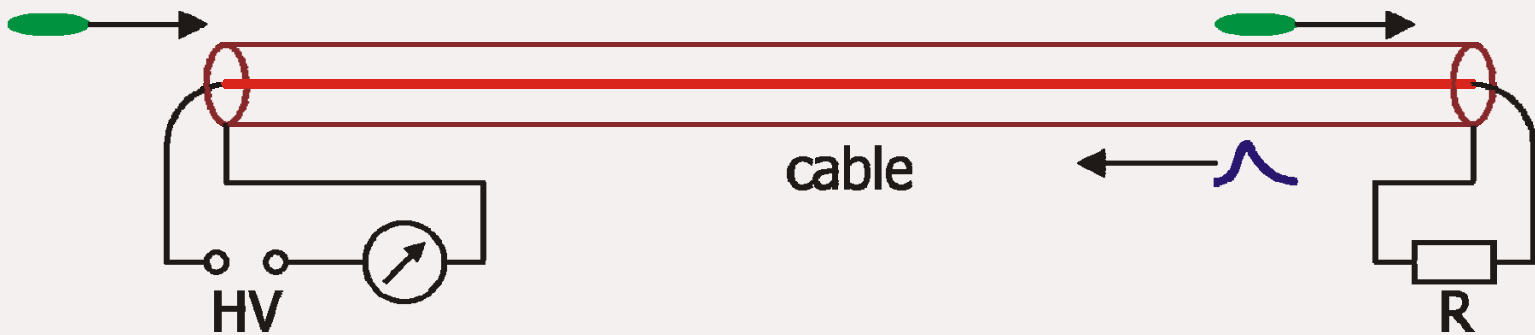

- Speed of light in cable: $>0.9c$
- Beam loss position to time: $\Delta t \approx 2\Delta z/c$
- Sampling rate: 100 MHz $\rightarrow \Delta z \approx 1.5$ m
- Maximum length determined by bunch spacing T
 $L_{\max} \approx 1/2 T \cdot c$
 $L_{\max} \approx 150$ m at $T=1 \mu\text{s}$ (1 MHz)
- obviously, **no position information for CW operation**

- **cable**
50 Ω , 2.2 cm diameter
- **gas filling**
95% Argon – 5% CO₂ at 55 kPa (0.55 bar)
- **high voltage**
500 V

- **time resolution**
<15 ns rise time,
~150 ns decay time

D. R. Patterson

difference of raw signals

- at near end of cable
- at far end of cable

raw signals from
+500V cable and
-500V cable

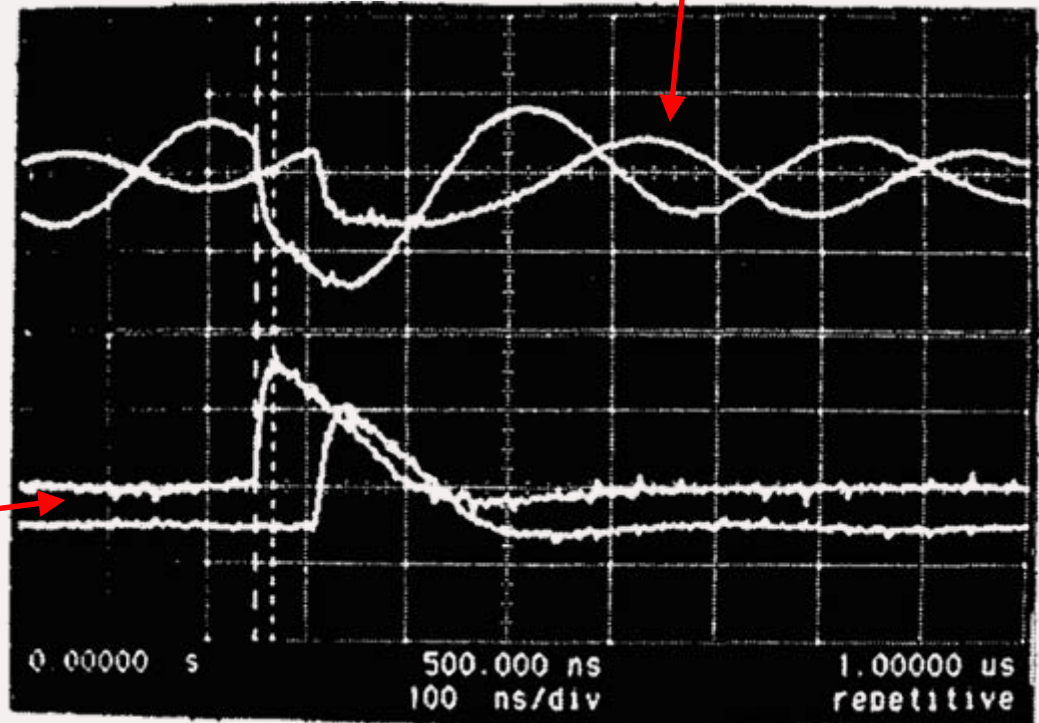

- 1.3 cm diameter air-filled coax cable
- 1 kV high voltage
- distance to beamline ~ 20 cm
- slow readout (100 ms integration)
- 1 long cable for machine protection
- 28 short cables for diagnostics (50 cm each)

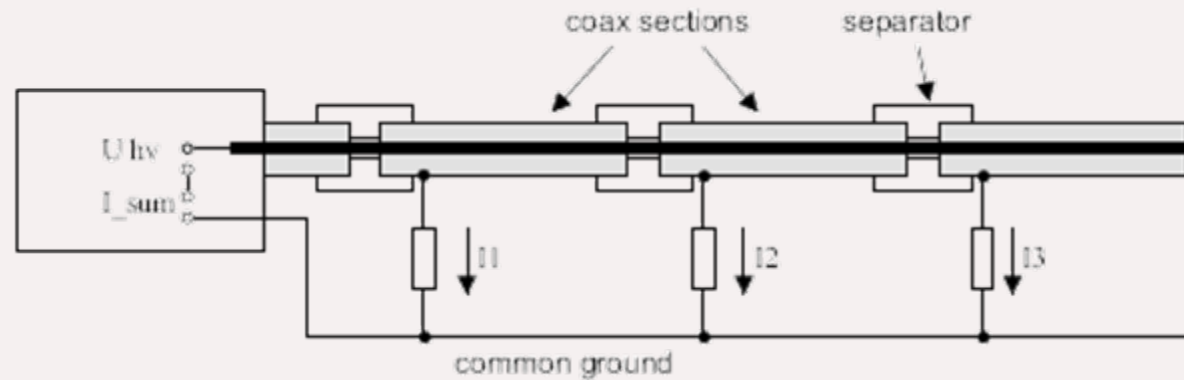
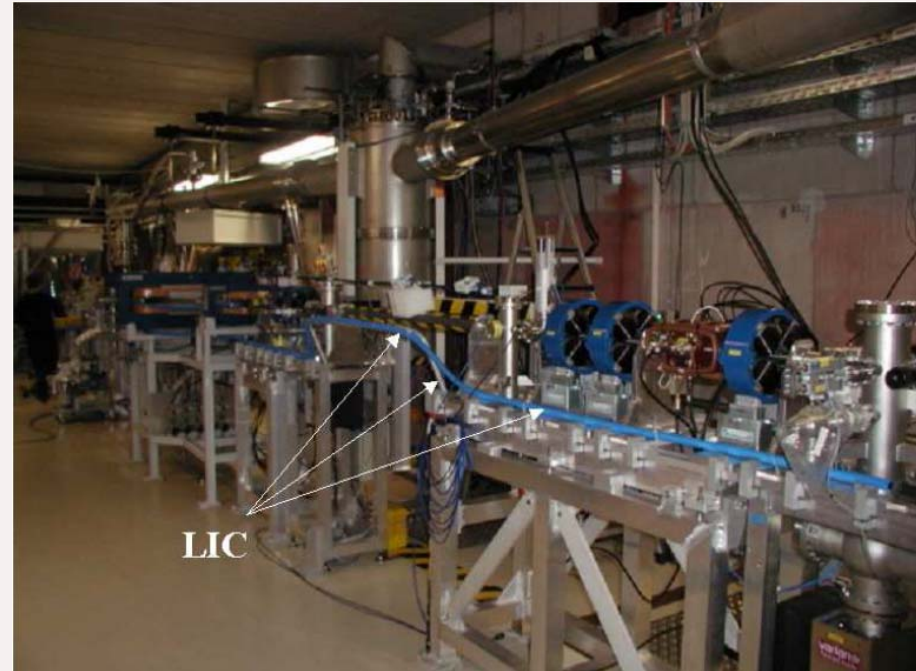

P. Michel, A. Büchner (ELBE)



BLM designs: PIN Diode

- diode with 3 sandwiched layers:
p doped — **i**ntrinsically conducting — **n** doped
- reverse biased (typ. 24 V)
- thick depletion zone without free charges ($\sim 100 \mu\text{m}$)
- ionizing radiation creates electron-hole pairs
→ current flow
- high specific sensitivity (3.6 eV/electron-hole pair),
but small active volume ($0.1\text{--}15 \text{ mm}^3$)
- used at HERA in coincidence counting mode
(two diodes back-to-back) to avoid
counting photons from SR background
- tests for HERA: no damage for $> 1 \text{ MGy}$

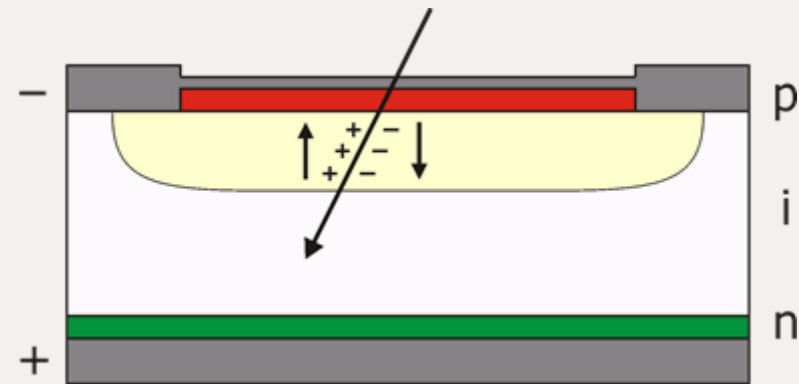



BLM designs: Secondary Emission Monitor

- diameter: 8.9 cm
- length: 15 cm
- electrodes: 250 μm Ti
- high voltage: ~ 1.5 kV
- high vacuum required to avoid ionization current:
better than 10^{-2} Pa (10^{-4} mbar)
→ integrated NEG ST707 foil to adsorb H_2
- fast (ns)
- good linearity
- low sensitivity
- radiation hard (some 10 MGy/a expected)
- ~ 300 used at LHC

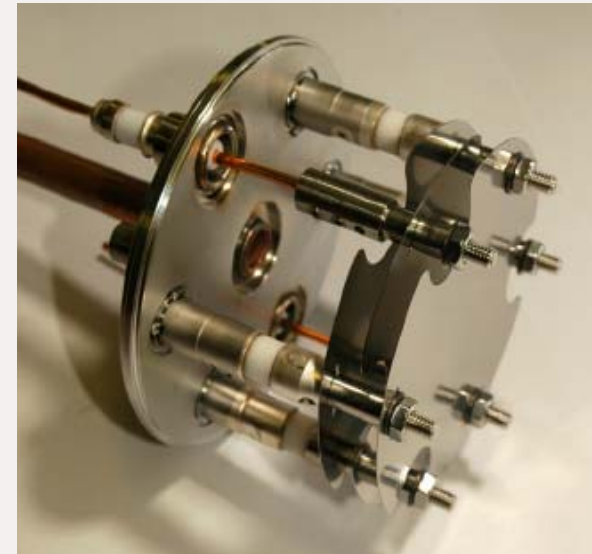
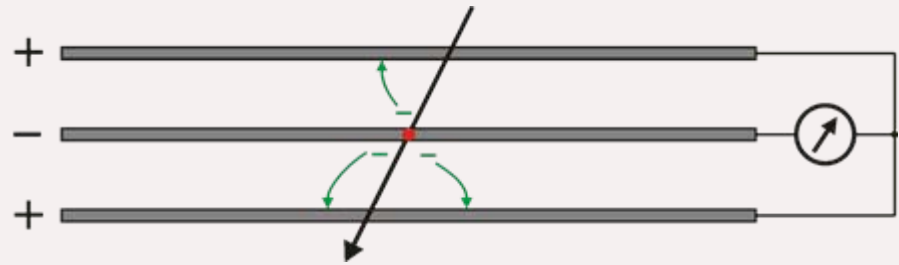

D. Kramer, B. Dehning (CERN)

- conventional photomultiplier tube with aluminum cathode (coated end window)
- high gain
(Thorn EMI 9841:
~3000 electrons per primary reaching the cathode)
- radiation hard
- no off-the-shelf device → expensive
- 18 used at FLASH in places of high expected losses (collimators, dipoles)

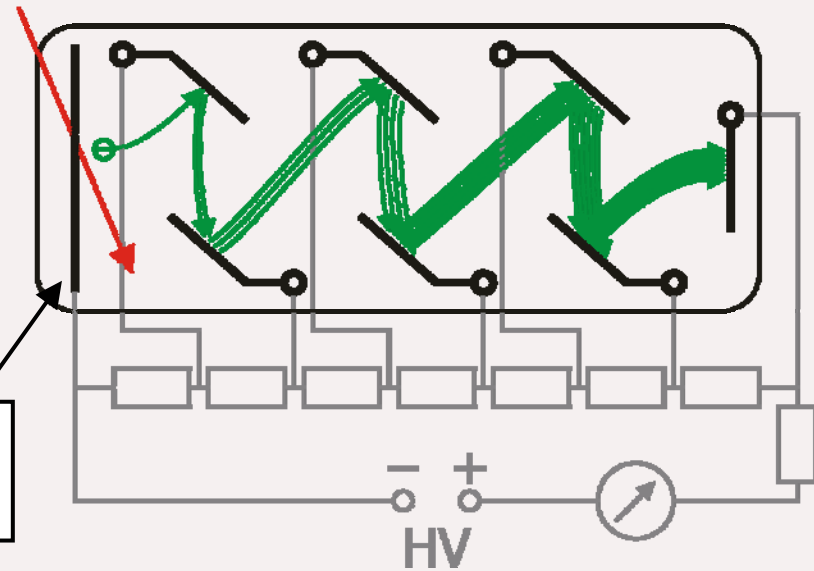
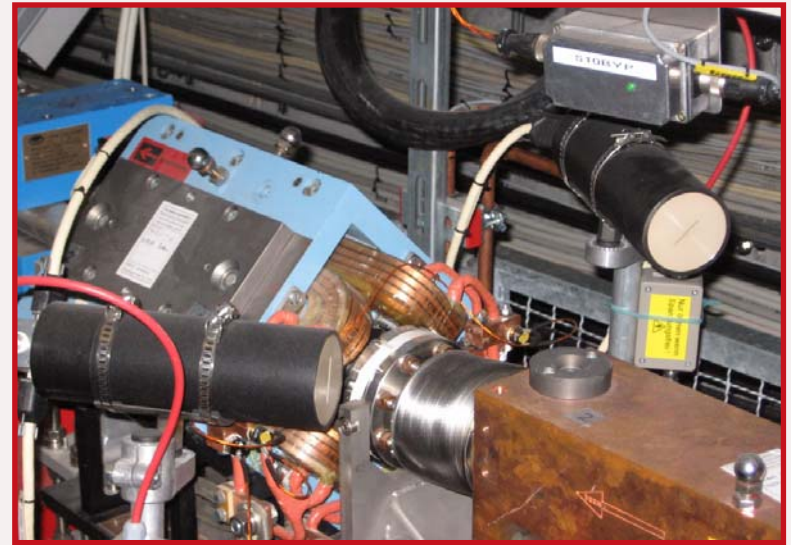

aluminum cathode
instead of photocathode



BLM designs: Photomultiplier with Bulk Scintillator

- **Inorganic crystals**

e.g. NaI, CsI with various dopants

~ **radiation hardness**: varying; 1/e after 1–10 kGy (CsI)

– **cost**: very expensive

CsI used at LEDA, Los Alamos (commercial PMT-scintillator combination from Bicron); several types used in HEP detectors

- **Liquid scintillators**

organic scintillator in organic solvent, e.g. xylene, toluene, ...

+ **radiation hardness**: 1/e after several 100 kGy or MGy

~ **cost**: liquid cheap, casing expensive

– **safety**: flammable (flash point –10 to +110 °C), some toxic

BLMs at LANSCE, Los Alamos (commercial PMT-scintillator combination from Bicron); paint can BLMs at Fermilab/Los Alamos (phased out)

- **Plastic scintillators**

organic scintillator dissolved in polymer base, e.g. polyvinyltoluene, polystyrene, ...

– **radiation hardness**: 1/e after several kGy to few 10 kGy

+ **cost**: cheap

+ **handling**: can cut arbitrary shapes

BLMs at FLASH, DESY (commercial PMT, inhouse assembly)



scintillator

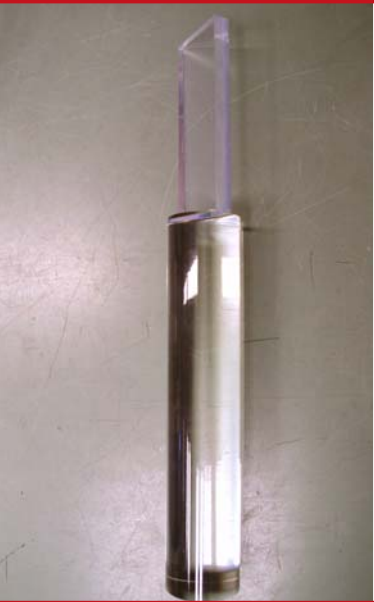

aluminum foil



black plastic foil
adhesive tape



plexiglass light guide

B. Michalek (DESY)

test pulse LED

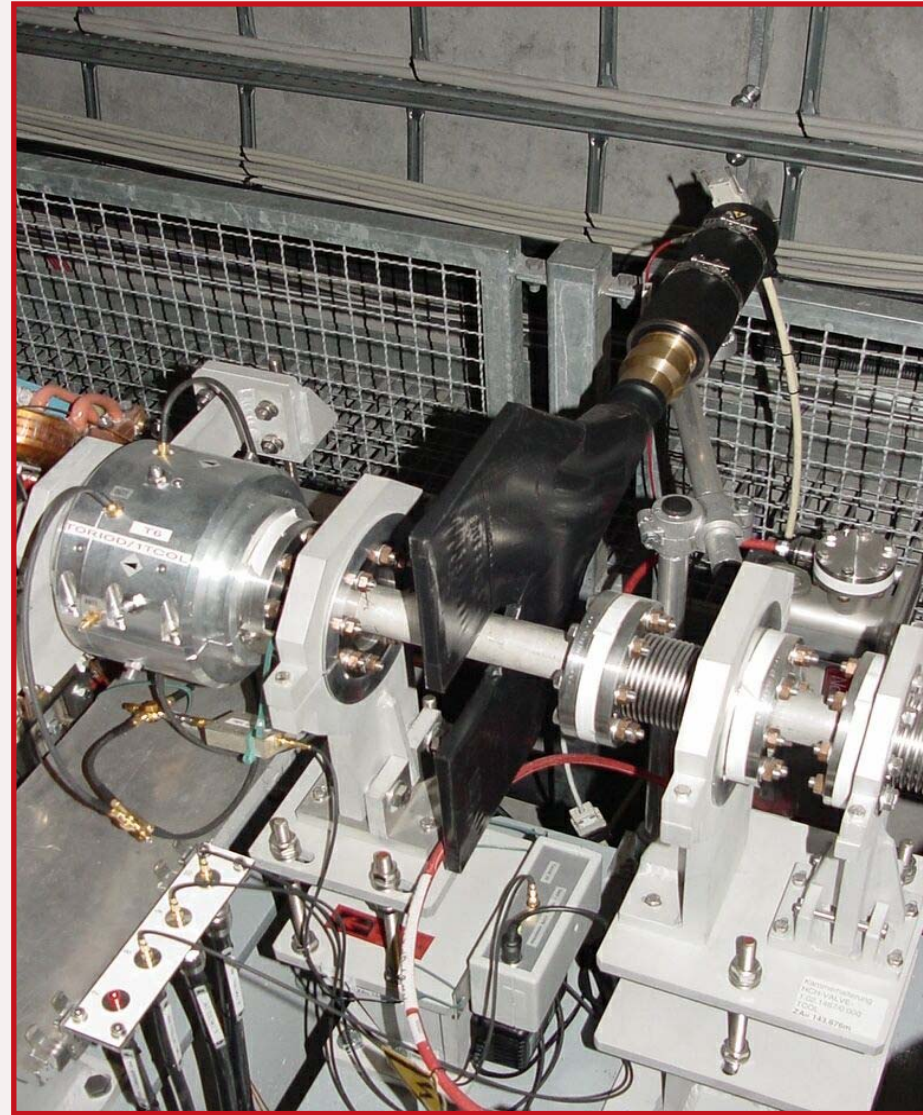
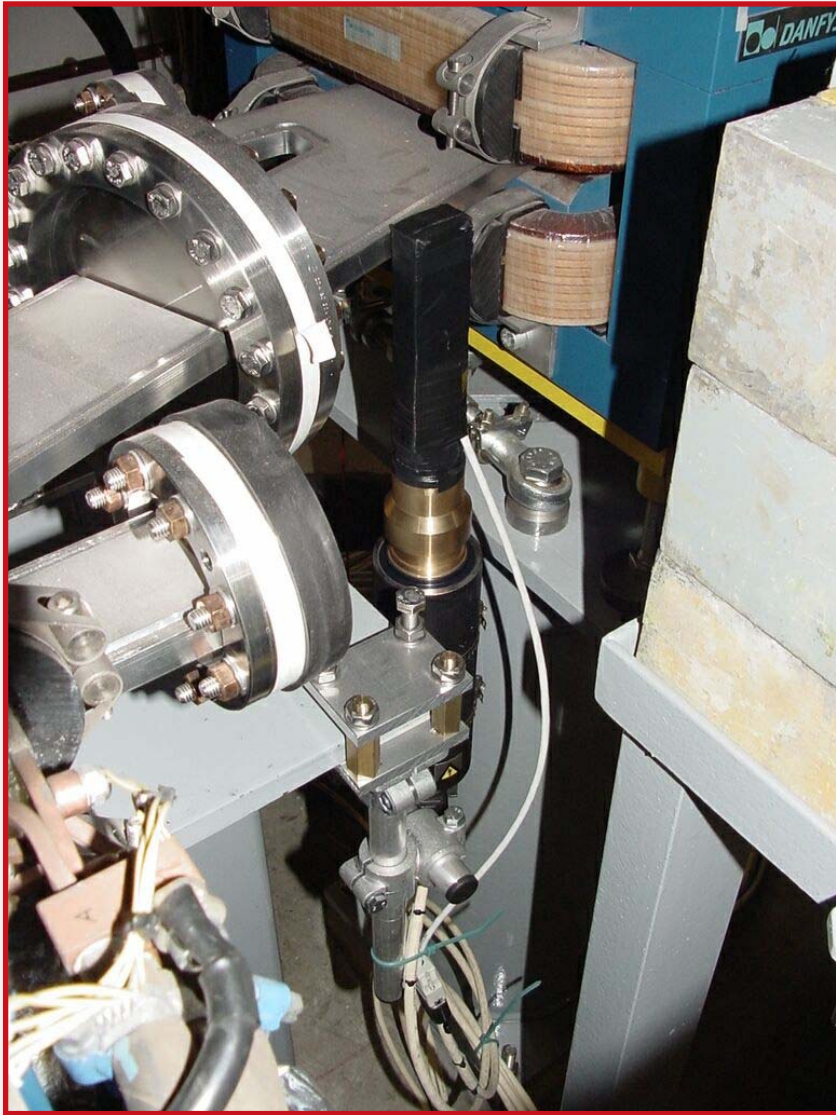



PMT With Bulk Scintillator



- **Extremely sensitive**
(electrons lose ~ 2 MeV/cm in scintillator, ~ 100 eV/photon \rightarrow 20000 photons/cm)
- **Very flexible**
(arbitrary scintillator shapes \rightarrow variable light output, variable high voltage \rightarrow gain variation by 10^3)
- **Very fast**
time resolution of few ns
- **Radiation damage problematic**
crystals too expensive
plastics unsuitable for high radiation areas
liquid scintillator better, but safety concerns

- **Expensive**

HV crate (~ 100 channels)	5000 €	} ~ 3000 € / piece + cabling + electronics
HV boards, per channel	250 €	
PMT	1000 €	
housing, mounting	1000 €	
scintillator + assembly	500 €	



BLM designs: Bare Photomultiplier

- **JLAB FEL:** detect Čerenkov light in PMT glass
- cheap 931B PMT, mainly blue sensitive
- quite radiation tolerant, darkening of glass compensated by HV ($\sim 10\%$ HV change needed this far)
- cheap housing (1.5" plastic water pipes)
- controls strong beam losses, trip level: $1 \mu\text{A}$ CW loss (160 W)
- for protection of insertion devices: additional ion chambers



Kevin Jordan, JLAB



BLM designs: Photomultiplier With Fibers

- 4 thick, radiation-hard fibers
- Čerenkov light read out by PMTs
- Longitudinal beam loss position from light propagation time
- Transverse beam loss position from correlation of 4 fibers

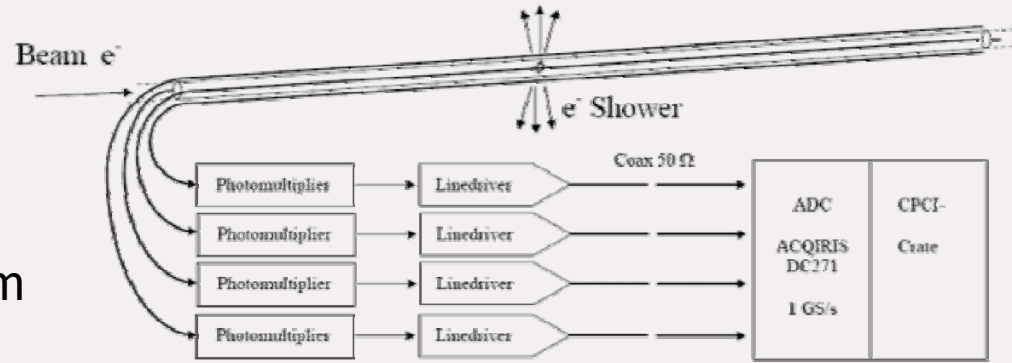

- **Fiber**
radiation hard (several 10 MGy)
300 μm core diameter
multi-mode, step-indexed
made by Heraeus
length: 35 m
- **Photomultiplier**
Hamamatsu H6780-02

M. Körfer (DESY), W. Goettmann,
F. Wulf (HMI), J. Kuhnenn (FhG)

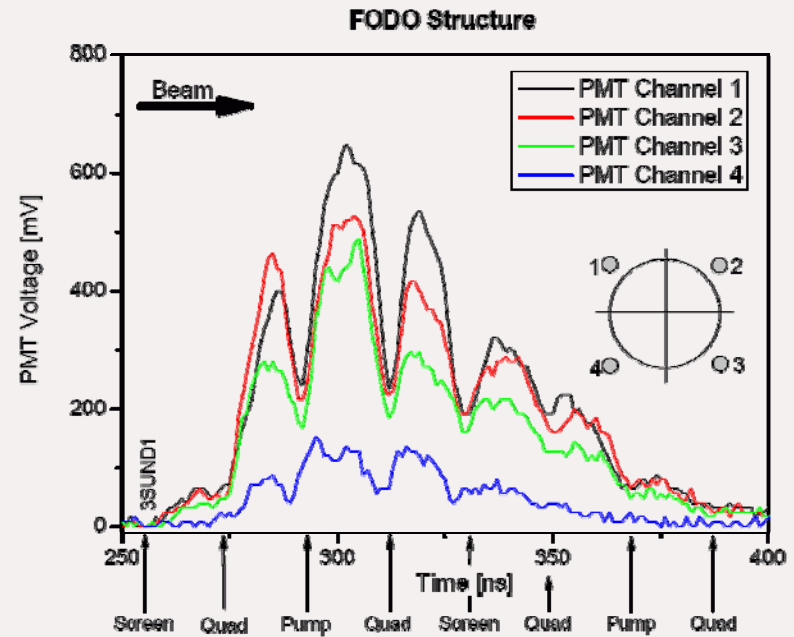

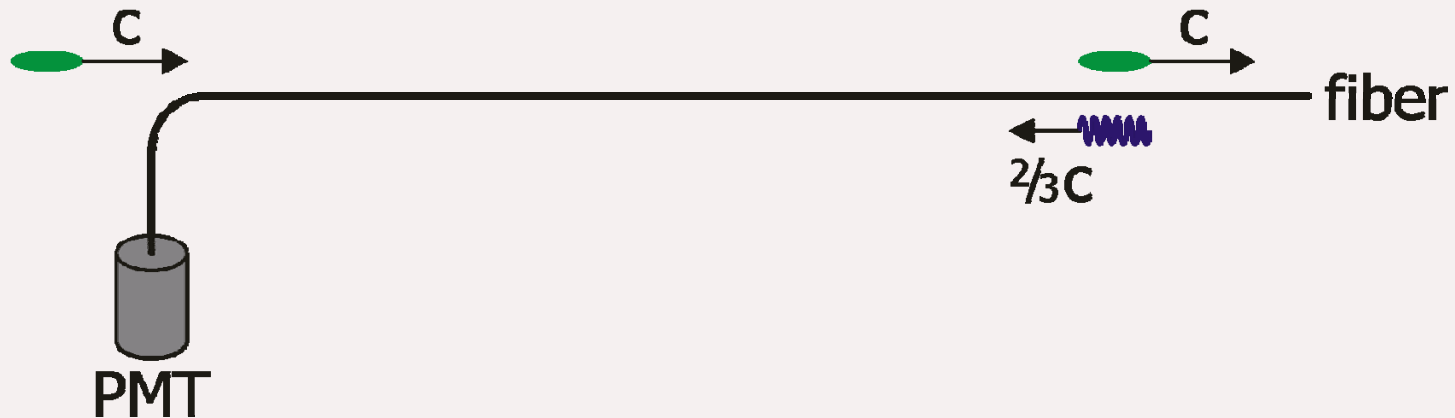

- Speed of light in fiber: $\sim 2/3 c$
- Beam losses by same bunch: $\Delta t \approx 5/2 \cdot \Delta z/c$
- Sampling rate: 1 GHz $\rightarrow \Delta z \approx 12$ cm
- Maximum fiber length determined by bunch spacing T
 $L_{\max} \approx 3/5 T \cdot c$
 $L_{\max} \approx 180$ m at $T=1 \mu\text{s}$ (1 MHz)
- obviously, **no position information for CW operation**

- Difference between left/right and top/down fibers gives transverse information (for symmetric geometry!)
- Accurate cross-calibration of PMTs important

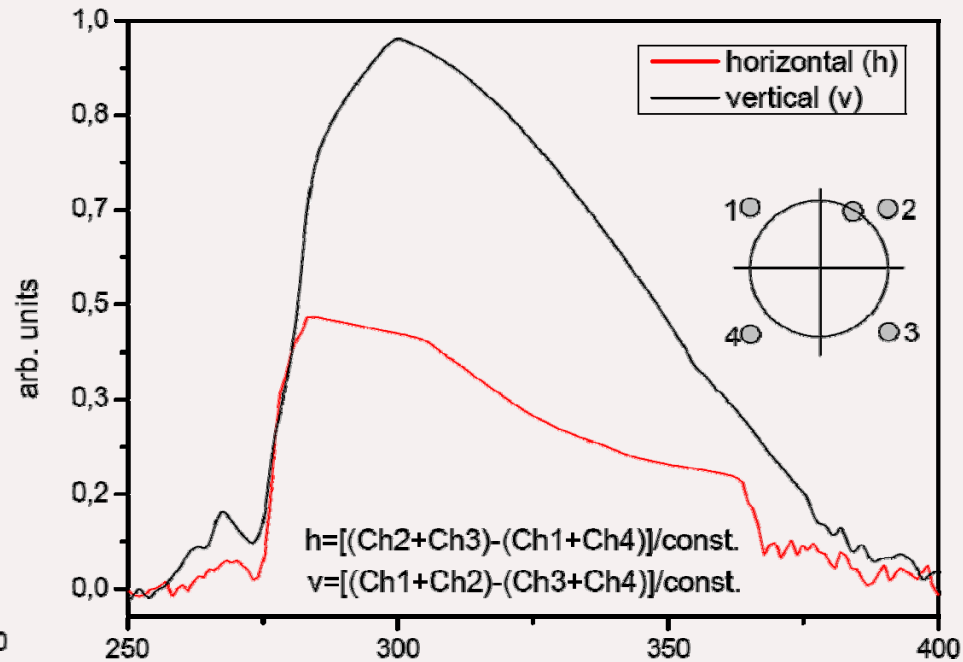
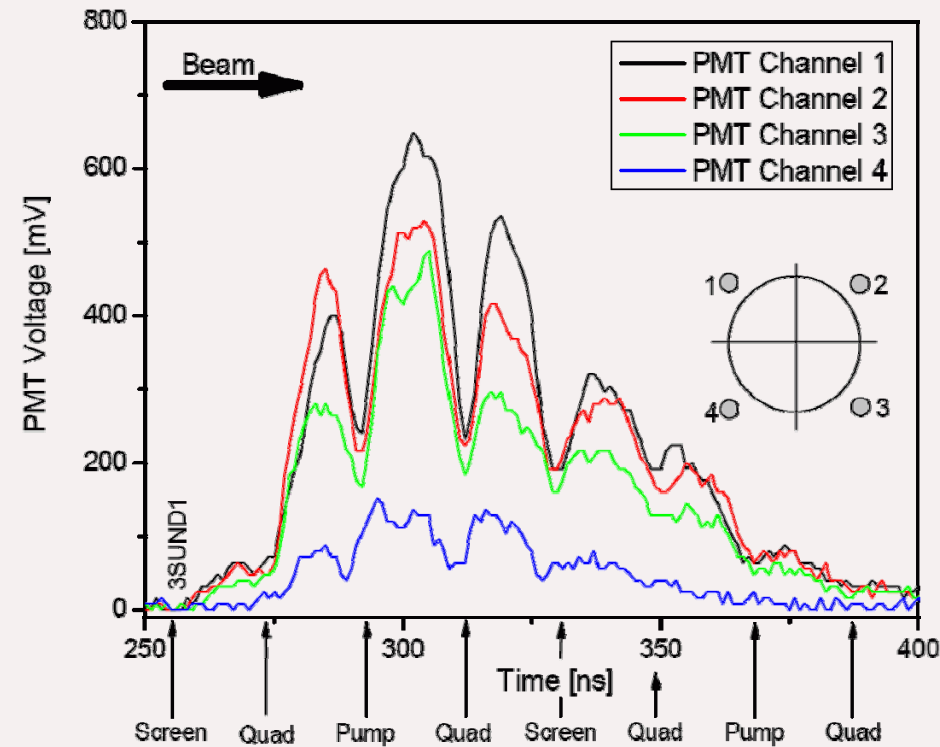

Fibers embedded in FLASH
undulator vacuum
chamber

U. Hahn

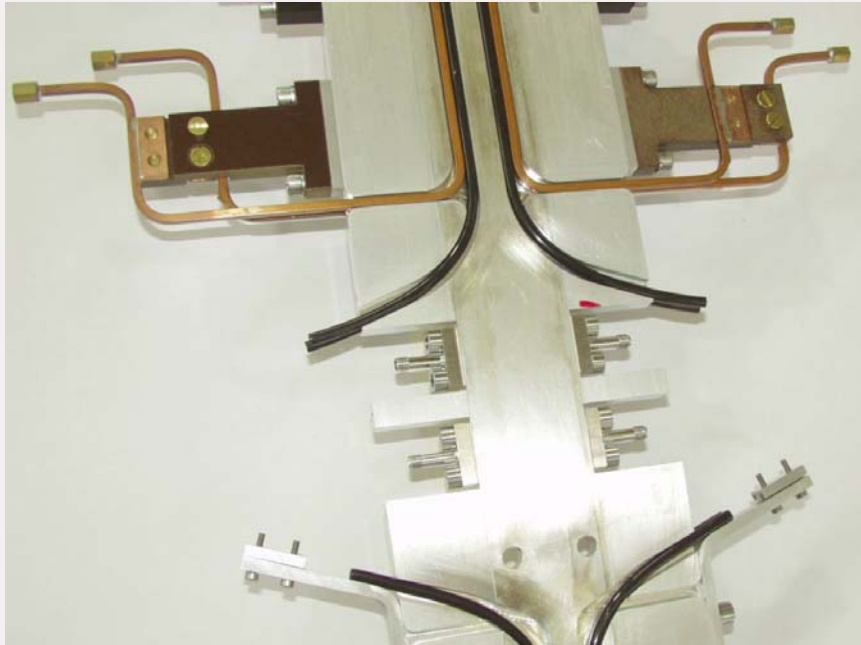

- Commercially available:
250 μm to 5 mm diameter
plastic scintillator core, one or two cladding layers of lower refractive index
- Trapping efficiency 3–7%
- High light output:
 ~ 8000 photons/MeV
- Attenuation length:
 ≤ 3 m \rightarrow not suited for long BLM

- Same radiation damage as
bulk plastic scintillator



Bicron catalog



Liquid-Core Scintillating Fibers



- Glass capillaries filled with organic liquid scintillator
- Diameter: down to 20 μm
- Trapping efficiency: $\sim 8\%$
- Attenuation length:
 $\leq 3 \text{ m} \rightarrow$ not suited for long BLM
- Radiation hardness: $\sim 1 \text{ MGy}$

- Used in particle physics detectors (e.g. CHORUS, CERN)



Examples: JLAB FEL

160 MeV electrons ▪ 10 mA ▪ 1.6 MW

- 48 cheap PMTs without scintillator (Čerenkov light)
- Trip level based on integrator with fixed threshold ($\sim 25 \text{ mA}\cdot\text{s}$)
- Calibration:
 - Run $1 \mu\text{A}$ CW beam into vulnerable location
 - Raise HV until BLM trips
 - Periodic check with internal test LED
 - Darkening and aging of PMTs compensated by HV ($\sim 10\%$ max.)
- Some PMTs available as floaters \rightarrow movable loss diagnostic

- 2 ionization chambers for wiggler protection (trip level: 2 Gy/h)
- Low energy injector:
 - Gamma probes as field emission diagnostic (for DC gun commissioning)
 - Sensitive ion pump current monitors ($< 1 \text{ MeV}$)

K. Jordan (JLAB)



- 256 X 32 full cross point switch for AMS and video (BW > 1 MHz)
 - **AMS in:** 48 analog BLM signals
 - **AMS out:** several Tek scopes with video output
 - **Video in:** video from Tek scopes
 - **Video out:** 32 outputs driving ~100 monitors, 8 web channels

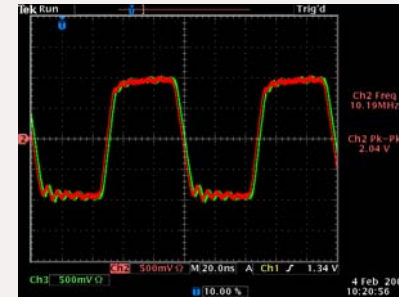
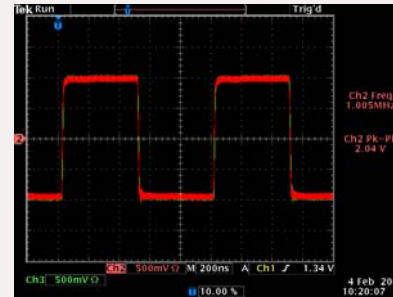

System IN and OUT signal overlaid,
2V P-P, left 1 MHz, right 10 MHz

K. Jordan (JLAB)

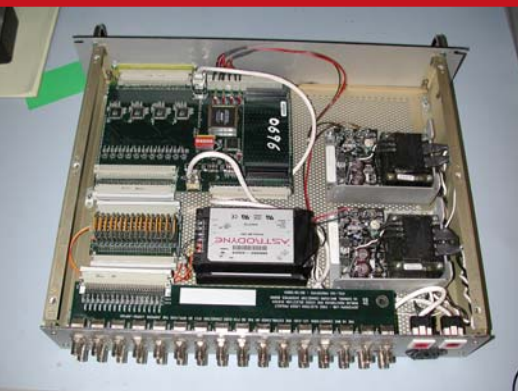

32 X 32 cross
point chassis



front view of
256 X 32 Configuration

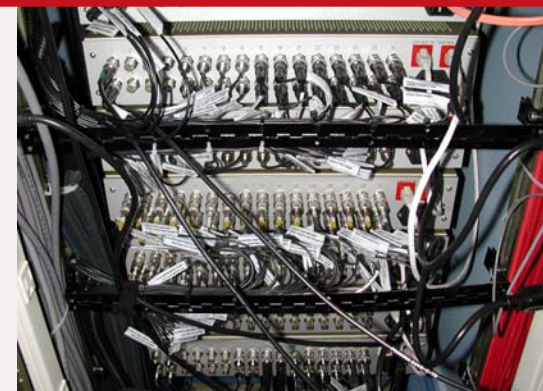

rear view
with cables



Examples: SNS

1 GeV protons ▪ 1.4 mA ▪ 1.4 MW

Beam Loss Monitor (BLM)

- ionization chamber
- steel casing against low energy x-rays
- detects only local, huge losses

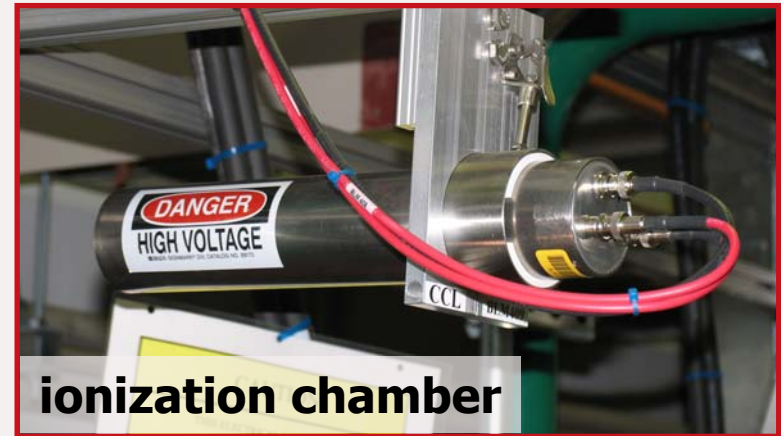

Neutron Detector (ND)

- photomultiplier with neutron-sensitive scintillator
- detects even remote, small losses

2 thresholds per BLM

- low threshold
against slow losses (10 s)
1 W/m criterion due to
activation
- high threshold
against fast losses (10 μ s)

sensitivity range

- lower limit
1% of 1 W/m
→ 300 pA
- upper limit
local 20 kW loss (1% beam
power)
→ 600 μ A
- span: $2 \cdot 10^6$

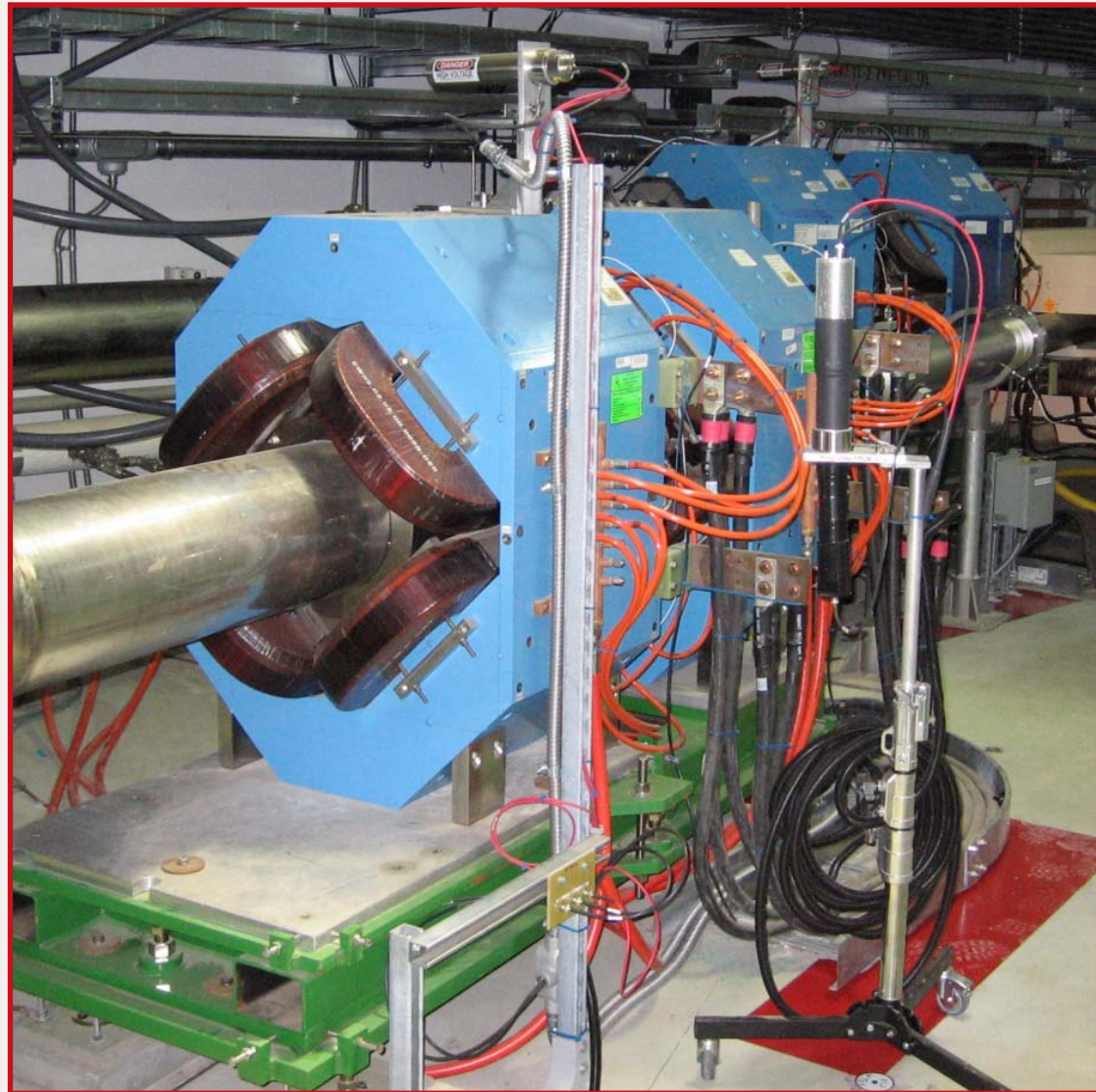



Examples: FLASH

1 GeV electrons ▪ 72 μA ▪ 72 kW

Beam Loss Monitors

- fast machine protection system: response time $< 4 \mu\text{s}$ incl. cables
- operation limited by beam and dark current losses in undulators ($< 10 \text{ Gy/d}$)
- radiation damage in scintillators at BC2 observed (dark current)

63 photomultipliers with scintillator panels



18 aluminum cathode electron multipliers

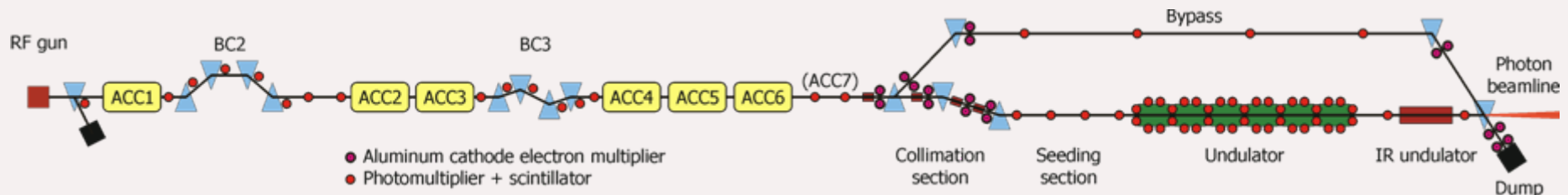
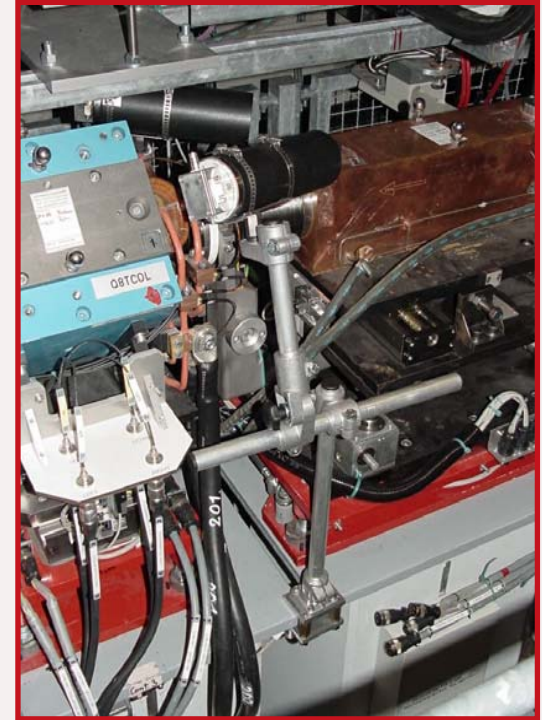

BLM Display

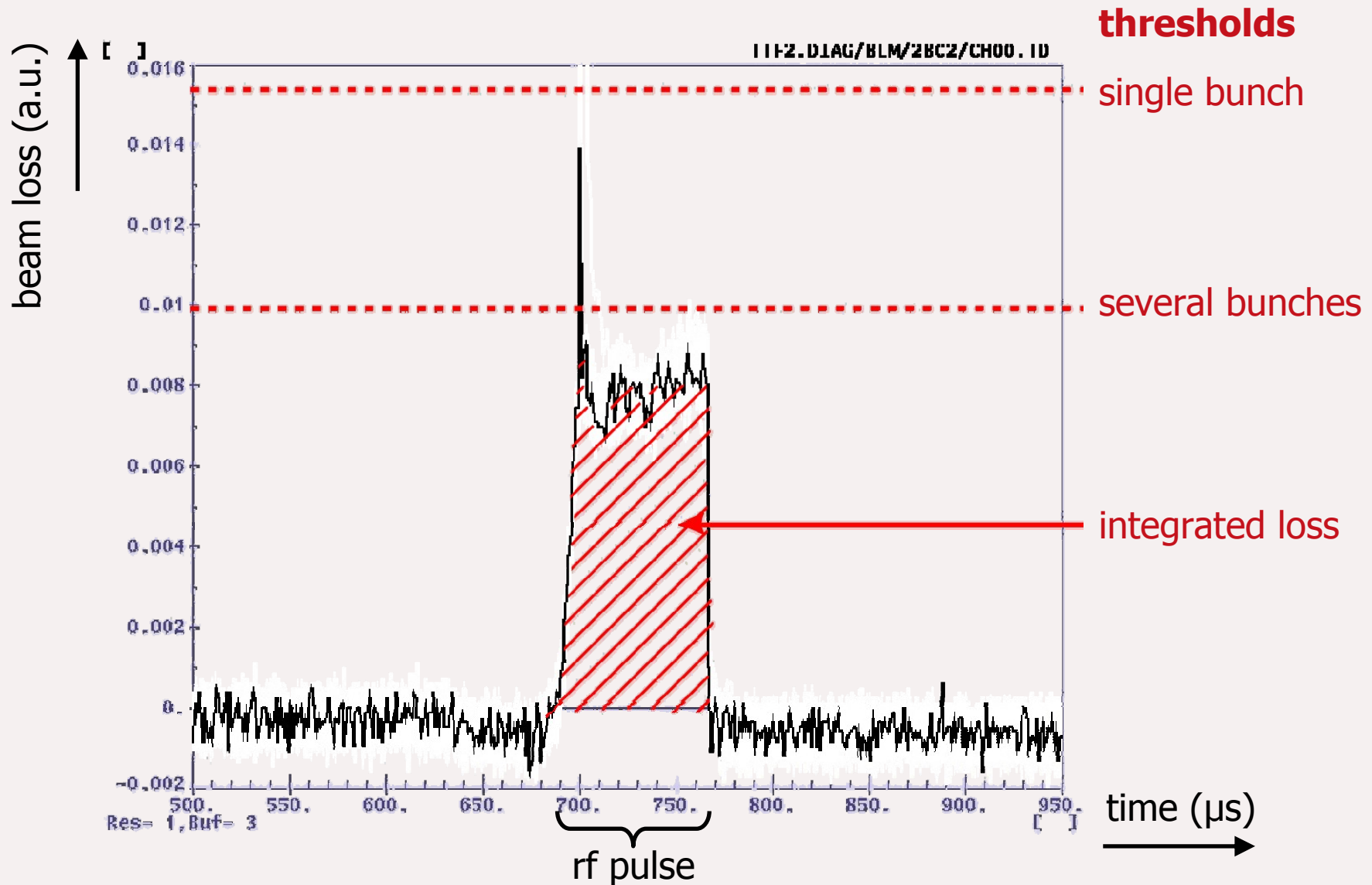



Summary

- Ionization chamber:** **70 $\mu\text{C}/\text{Gy}$**
 1 liter argon
 $S \approx \text{active mass} \cdot \text{charge per ionization energy} \approx V \cdot \rho \cdot e / E_{\text{ion}} \approx 1 \text{ l} \cdot 1.8 \text{ g/l} \cdot e / 26 \text{ eV}$
- Long ionization chamber:** **20 $\mu\text{C}/\text{Gy}$**
 1 meter length, 1 cm radius, argon
 $S \approx \text{active mass} \cdot \text{charge per ionization energy} \approx \pi r^2 \cdot L \cdot \rho \cdot e / E_{\text{ion}} \approx 314 \text{ cm}^3 \cdot 1.8 \text{ g/l} \cdot e / 26 \text{ eV}$
- PIN diode:** **6 $\mu\text{C}/\text{Gy}$**
 1 cm^2 surface, 100 μm depletion depth
 $S \approx \text{active mass} \cdot \text{charge per excitation energy} \approx A \cdot d \cdot \rho \cdot e / E_{\text{ion}} \approx 10 \text{ mm}^3 \cdot 2.3 \text{ g/cm}^3 \cdot e / 3.6 \text{ eV}$
- Secondary emission monitor:** **500 pC/Gy**
 100 cm^2 surface, 0.01 average secondary emission yield (SEY)
 $S \approx \text{surface} \cdot \text{SEY} \cdot \text{electron charge} \cdot \text{density of primaries per dose} \approx A \cdot \text{SEY} \cdot e \cdot (\rho / (dE/dx))$
 $\approx 100 \text{ cm}^2 \cdot 0.01 \cdot e \cdot 1 / (2 \text{ MeV} \cdot \text{cm}^2/\text{g})$
- Aluminum cathode electron multiplier:** **5 $\mu\text{C}/\text{Gy}$**
 10 cm^2 surface, 0.01 average secondary emission yield (SEY), tube gain 10^5
 $S \approx \text{surface} \cdot \text{SEY} \cdot \text{electron charge} \cdot \text{density of primaries per dose} \cdot \text{gain} \approx A \cdot \text{SEY} \cdot e \cdot (\rho / (dE/dx)) \cdot G$
 $\approx 10 \text{ cm}^2 \cdot 0.01 \cdot e \cdot 1 / (2 \text{ MeV} \cdot \text{cm}^2/\text{g}) \cdot 10^5$
- PMT with organic scintillator:** **200 C/Gy** ← **Radiation damage problematic!**
 1 liter scintillator, 60% collection efficiency, 30% photocathode efficiency, tube gain 10^5
 $S \approx \text{active mass} \cdot \text{photon yield per energy} \cdot \text{collection efficiency} \cdot \text{photocathode efficiency} \cdot \text{gain} \cdot \text{electron charge}$
 $\approx V \cdot \rho \cdot Y \cdot C \cdot P \cdot G \cdot e = 1 \text{ l} \cdot 1 \text{ g/cm}^3 \cdot 1 / (100 \text{ eV}) \cdot 0.6 \cdot 0.3 \cdot 10^5 \cdot e$
- Bare PMT (Čerenkov light):** **4 mC/Gy**
 10 cm^2 surface, 1 mm thick, 30% photocathode efficiency, tube gain 10^5
 $S \approx \text{active volume} \cdot \text{density of primaries per dose} \cdot \text{photon yield per length} \cdot \text{photocath. efficiency} \cdot \text{gain} \cdot \text{electron charge}$
 $\approx A \cdot d \cdot \rho \cdot (\rho / (dE/dx)) \cdot Y \cdot P \cdot G \cdot e \approx 1 \text{ cm}^3 \cdot 1 / (2 \text{ MeV} \cdot \text{cm}^2/\text{g}) \cdot 260/\text{cm} \cdot 0.3 \cdot 10^5 \cdot e$
- PMT with Čerenkov fiber:** **2 $\mu\text{C}/\text{Gy}$**
 1 meter length, 100 μm radius, 2% collection efficiency, 30% photocathode eff., tube gain 10^5
 $S \approx \text{active volume} \cdot \text{density of primaries per dose} \cdot \text{photon yield per length} \cdot \text{coll. eff.} \cdot \text{photoc. eff.} \cdot \text{gain} \cdot \text{electron charge}$
 $\approx \pi r^2 \cdot L \cdot \rho \cdot (\rho / (dE/dx)) \cdot Y \cdot C \cdot P \cdot G \cdot e \approx 31 \text{ mm}^3 \cdot 1 / (2 \text{ MeV} \cdot \text{cm}^2/\text{g}) \cdot 260/\text{cm} \cdot 0.02 \cdot 0.3 \cdot 10^5 \cdot e$

Flexible gain → linearity and calibration problematic!

Kay Wittenburg (DESY)

Kevin Jordan (JLAB)

Alexander Zhukov (SNS)

Gero Kube (DESY)

Bernd Dehning (CERN)

